



Read and Save These Instructions

All Hoods Should Be Installed By A Qualified Installer

INSTALLATION INSTRUCTIONS

LOW PROFILE UNDER CABINET HOOD

WARNING - TO REDUCE THE RISK OF FIRE, ELECTRIC SHOCK, OR INJURY TO PERSONS, OBSERVE THE FOLLOWING:

- A. Installation work and electrical wiring must be done by qualified person(s) in accordance with all applicable codes and standards, including fire-rated construction.
- B. When cutting or drilling into wall or ceiling, do not damage electrical wiring and other hidden utilities.
- C. Ducted fans must always be vented to the outdoors.
- D. Sufficient air is needed for proper combustion and exhausting of gases through the flue (chimney) of fuel burning equipment to prevent back drafting. Follow the heating equipment manufacturer's guideline and safety standards such as those published by the National Fire Protection Association (NFPA), and the American Society for Heating, Refrigeration and Air Conditioning Engineers (ASHRAE), and local code authorities.

WARNING - TO REDUCE THE RISK OF FIRE, USE ONLY METAL DUCTWORK

Ducting Do's and Don'ts

NEVER restrict the duct size. The blower unit (K250) requires 3 1/4" x 10" rectangular duct, 7" round duct, or equivalent (32.5 square inches). When possible, use Vent-A-Hood transitions.

Do not use flexible or corrugated duct. This type of duct will restrict air flow and reduce performance. Only use smooth galvanized metal duct. Observe local codes regarding special duct requirements and placement of duct against combustibles.

Make the duct run as short and as straight as possible with as few turns as possible. Avoid sharp angled turns. Instead, use smooth gradual turns such as adjustable elbows or 45 degree angled turns.

Use a Vent-A-Hood roof jack or wall louver whenever possible. Air must not be restricted at the end of duct run; do not use screen wire or spring loaded doors on wall louvers or roof jacks. Do not terminate vent into an attic or chimney. The hood must be ducted to the outdoors.

YES

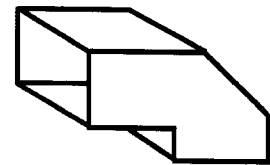
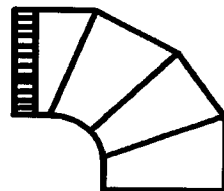

NO

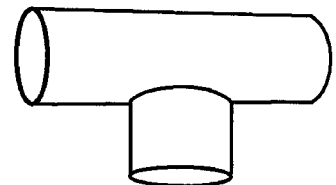
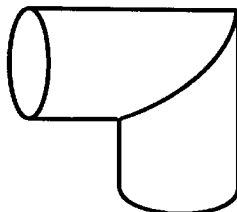
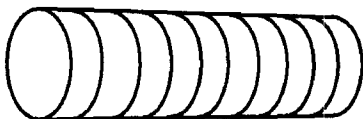

Vent-A-Hood®

Installation Details

- 1) Read all instructions thoroughly before beginning installation.
- 2) Inspect the underside of cabinet for a flush mounting surface. If the underside of the cabinet is recessed, install woodstrips to provide a flush surface for the hood mounting screws to engage.
- 3) Determine whether the hood will discharge horizontally or vertically. The hood is shipped to discharge vertically but is easily converted to horizontal discharge by swapping the discharge adapter on top of the hood (4 screws) with the discharge cover on the back of the hood (2 screws). Use duct tape to seal the discharge adapter and discharge cover to the hood.
- 4) Pre-install the duct from the outside of the home to the hood. A list of applicable Vent-A-Hood ducting materials is on the back page of this instruction sheet. Consult blower outlet and hood placement diagrams for duct location.

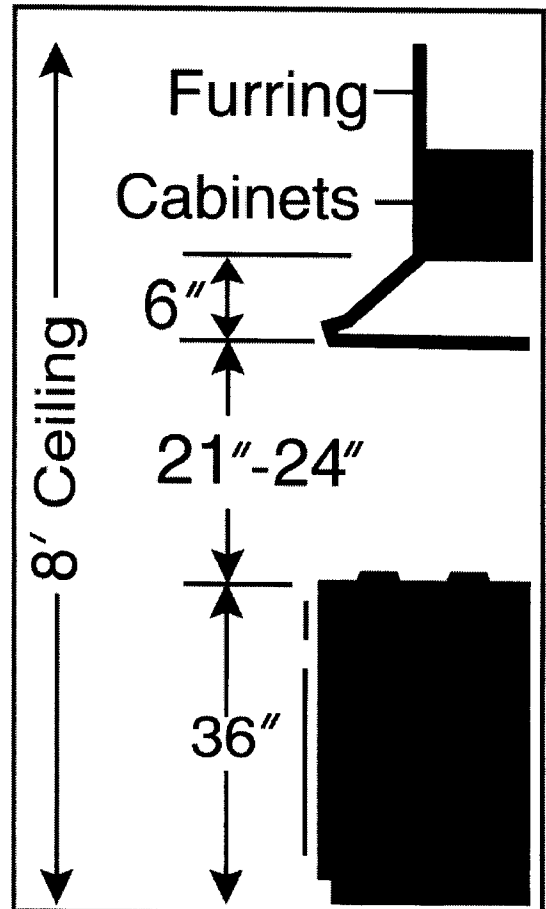
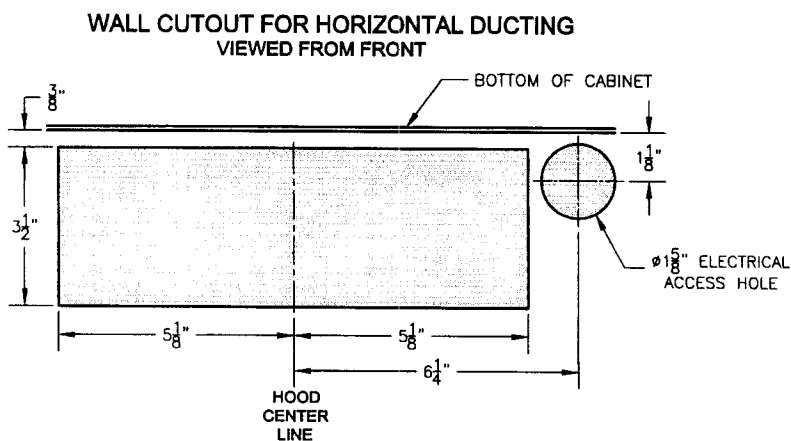
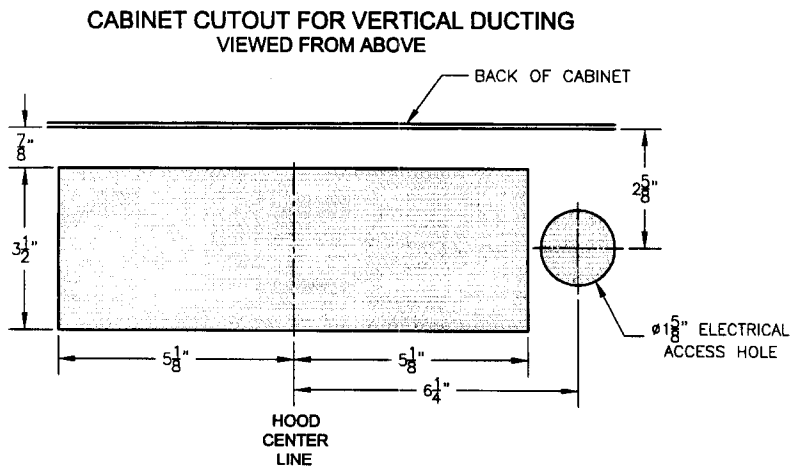

Installation Details Continued

- 5) Determine whether the electrical wire will enter from the top or back of the hood. Remove the electrical enclosure (2 screws) and remove the top or back electrical enclosure knock-out from the hood. Install an approved electrical wire clamp through the electrical enclosure knock-out. Pre-install electrical wiring from the electrical panel to the hood location.
- 6) Line the hood up near the underside of cabinet. Insert the electrical wire through the electrical wire clamp allowing 3" to 4" of wire inside the enclosure for hook-up. Tighten the electrical wire clamp.
- 7) Align the hood with the duct and place the hood in the finished position under the cabinet. Using the four screws provided, screw the hood to the bottom of the cabinet. Use duct tape to seal duct connection.
- 8) Connect the electrical wire and replace the electrical box cover. Test hood.

<u>Volts</u>	<u>Amps</u>	<u>Hz</u>
115	3.2	60

CFM and Ducting Information- K250/K250H

<u>Application</u>	<u>RPM</u>	<u>Equiv. CFM**</u>	<u>CFM @SP .0"</u>	<u>CFM @SP.1"</u>	<u>CFM @SP.2"</u>	<u>CFM @SP.3"</u>
Top Vent High	1550	360	240	225	215	200
Top Vent Low	1200	255	170	170	160	155
Back Vent High	1550	330	220	215	195	180
Back Vent Low	1200	265	175	170	160	145

** Equivalent cfm: The Magic Lung 250 CFM blower is capable of handling cooking equipment with 360 CFM requirements due to centrifugal filtration as opposed to mesh filter or baffle filtration.

Ducting Materials Available from Vent-A-Hood

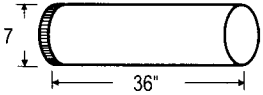
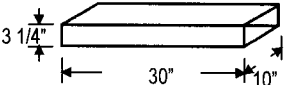
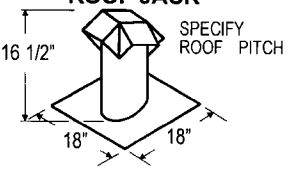
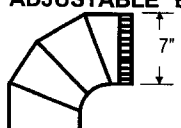
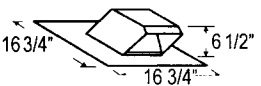
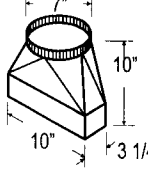
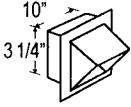
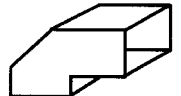
<p>ROUND VENT DUCT</p>  <p>MODEL DIM</p> <hr/> <p>VP501 7"</p>	<p>3 1/4" RECTANGLE DUCT</p>  <p>MODEL DIM</p> <hr/> <p>VP504 3 1/4" X 10"</p>	<p>ROOF JACK</p>  <p>MODEL DIM</p> <hr/> <p>VP509 7"</p>	<p>ADJUSTABLE ELBOW</p>  <p>MODEL DIM</p> <hr/> <p>VP514 7"</p>
<p>LOW PROFILE ROOF JACK</p>  <p>(MAX 4/12 PITCH)</p> <p>MODEL DIM</p> <hr/> <p>VP540 7"</p>	<p>3 1/4" x 10" to 7" TRANSITION</p>  <p>MODEL DIM</p> <hr/> <p>VP521 3 1/4" X 10" TO 7"</p>	<p>WALL LOUVER</p>  <p>MODEL DIM</p> <hr/> <p>VP560 3 1/4" x 10"</p>	<p>BACK VENT ELBOW</p>  <p>MODEL DIM</p> <hr/> <p>VP559 3 1/4" x 10"</p>