



**Read and Save These Instructions**  
All Hoods Must Be Installed By A Qualified Installer  
**INSTALLATION INSTRUCTIONS**  
**CWLH9 WALL MOUNT HOOD**

**Read All Instructions Thoroughly Before Beginning Installation**

**WARNING - TO REDUCE THE RISK OF FIRE, ELECTRIC SHOCK, OR INJURY TO PERSONS, OBSERVE THE FOLLOWING:**

- A. Installation work and electrical wiring must be done by qualified person(s) in accordance with all applicable codes and standards, including fire-rated construction. Switch power off at service panel and lock the service disconnecting means to prevent power from being switched on accidentally during installation.**
- B. When cutting or drilling into wall or ceiling, do not damage electrical wiring and other hidden utilities.**
- C. Ducted fans must always be vented to the outdoors.**
- D. Sufficient air is needed for proper combustion and exhausting of gases through the flue (chimney) of fuel burning equipment to prevent back drafting. Follow the heating equipment manufacturer's guideline and safety standards such as those published by the National Fire Protection Association (NFPA), and the American Society for Heating, Refrigeration and Air Conditioning Engineers (ASHRAE), and local code authorities.**

**WARNING - TO REDUCE THE RISK OF FIRE, USE ONLY METAL DUCTWORK**

# *Vent-A-Hood*<sup>®</sup>

## Ducting Do's and Don'ts

**NEVER** restrict the duct size. The single blower unit (B100) requires 6" round duct or equivalent (28 square inches), and the dual blower unit (B200) requires 8" round duct or equivalent (50 square inches). When combining ducts together, the square inch area must reflect the total square inch area of the ducts being combined. Using Vent-A-Hood transitions (back page) will ensure proper efficiency.

Blower	Duct Size	Sq. Inch Area	Vent-A-Hood Transition
Single (B100)	6" round or equivalent	28"	N/A
Dual (B200)	8" round or equivalent	50"	N/A
Single and Dual (B100 & B200)	10" round or equivalent	79"	VP562 (Optional)
Two Dual (Two B200s)	12" round or equivalent	113"	VP563 (Optional)

Do not use flexible or corrugated duct. This type of duct will restrict air flow and reduce performance. Only use smooth galvanized metal duct. Observe local codes regarding special duct requirements and placement of duct against combustibles. Make the duct run as short and as straight as possible with as few turns as possible. Avoid sharp angled turns. Instead, use smooth gradual turns such as adjustable elbows or 45 degree angled turns. For duct runs over 20 feet, increase duct diameter by one inch for every ten feet of duct. A 90 degree elbow is equivalent to 5 feet of duct. Using Vent-A-Hood roof jacks or wall louvers (back page) will ensure proper efficiency. Air must not be restricted at the end of duct run. Do not use screen wire or spring loaded doors on wall louvers or roof jacks. Do not terminate vent into an attic or chimney. The hood must be ducted unrestricted to the outdoors.

YES



Smooth Duct

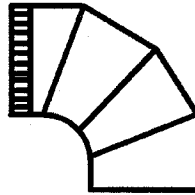

Smooth Gradual Turn

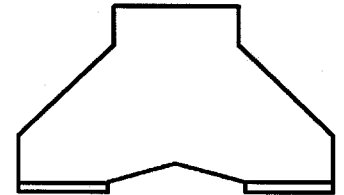

Proper Combining of Two Ducts

NO

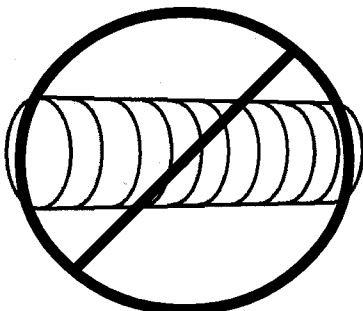

Flexible Duct

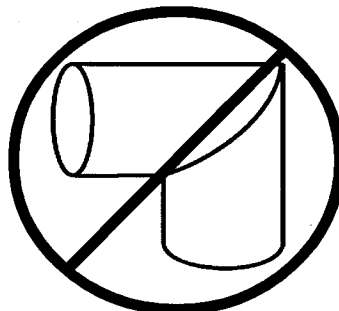

Sharp Angled Turns

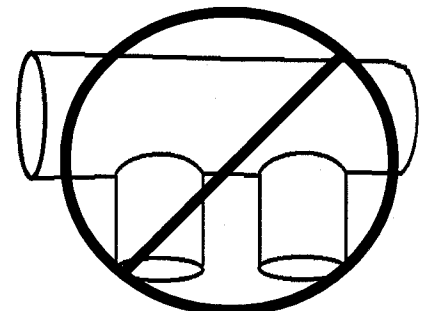

Improper Combining of Two Ducts

# Vent-A-Hood®

## Installation Details

- 1) Read all instructions thoroughly before beginning installation.
- 2) When installing the CWLH9, it is recommended that the bottom edge of the hood be located 27" from the countertop.

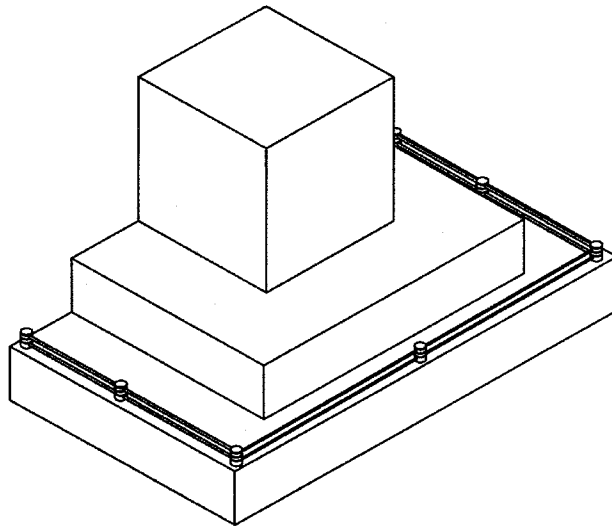

Shown with duct cover installed (sold separately).

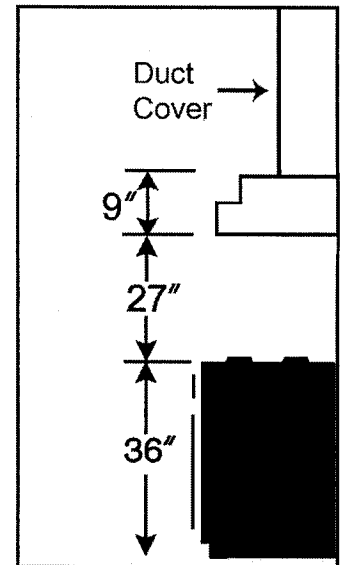

- 3) Select an installation method. Method 1 allows the hood and duct cover to be installed together as a single unit. The final duct connection is made at the ceiling as the hood is attached to the wall. Method 2 allows the duct cover to be slid into place after the hood is attached to the wall. Caution must be taken when using this method to prevent scratching the top of the hood or the ceiling.
- 4) IF THE HOOD IS TO BE "BACK VENTED", PROCEED DIRECTLY TO STEP 5.

Consult the connection diagrams (on next page) for further details on exhaust outlet placement.

**Method 1:** Pre-install the duct from the outside of the home to the ceiling over the exhaust outlet of the hood. The end of the duct should extend 1" below the ceiling.

**Method 2:** Pre-install the duct down to the location of the hood exhaust outlet allowing room for the transition on the top of the hood (if applicable). If a transition is used, install duct down to the location of the transition outlet plus 1". This will allow the transition to engage 1" inside of duct.

Use duct tape to seal all joints. A complete listing of available Vent-A-Hood ducting materials is provided on the back page of this instruction sheet.

Transition heights are as follows:

**Single Blower (B100) :** 6" round duct will connect directly to the top of the hood.

**Dual Blower (B200) :** 8" round duct will connect directly to the top of the hood.

**Single and Dual Blower (B100 & B200):** 6" round duct will connect directly to the top of the hood; 8" round will connect directly to the top of the hood. Optional 10" round combination transition (VP562, sold separately) is 17 1/2" tall.

**Two Dual Blowers (Two B200s):** Two 8" rounds connect directly to the top of the hood. Optional 12" round combination transition (VP563, sold separately) is 16 1/2" tall.

## See Next Page For More Installation Details

## Installation Details Continued

### Connection Diagrams 30"- 48" Widths

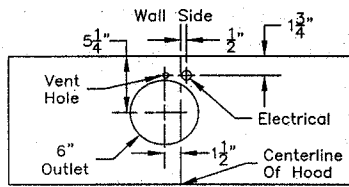

**300 CFM B100 Single Blower  
(Top View)**

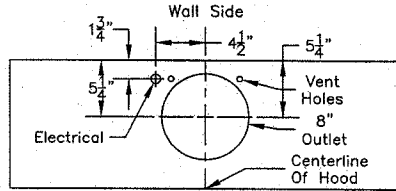

**600 CFM B200 Dual Blower  
(Top View)**

### Connection Diagram 54"- 60" Widths

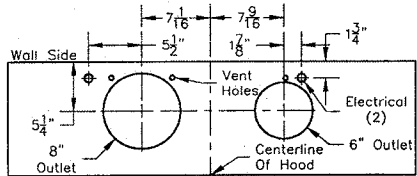

**900 CFM B200 Dual & B100 Single Blower  
(Top View)**

### Connection Diagram 60"- 66" Widths

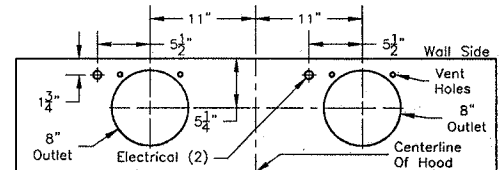

**1200 CFM Double B200 Dual Blowers  
(Top View)**

- 5) Remove the hood from the packaging and place the back of the hood on the floor or countertop in front of the wall where it will hang.
- 6) Remove the blower shield (A) by loosening the two brass screws on the bottom of the shield. To remove the blower housing, un-snap the suitcase latches (B) (one on each side of the housing). The housing should be pulled forward and gently "tipped" to clear the blower wheel(s) and then out of the hood.

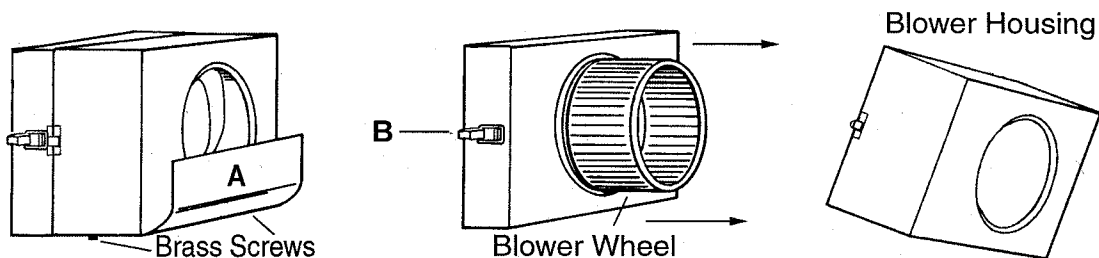

- 7) Remove the three screws retaining the blower motor(s). Unplug and remove the motor(s), taking care not to damage the blower wheel(s). It is not necessary to remove the blower wheel from the motor.

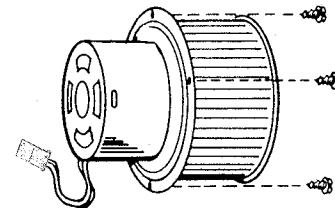

**Warning: Make sure power is off and locked at the service disconnecting means on the service panel during installation.**

**See Next Page For More Installation Details**

## Installation Details Continued

- 8) Install the appropriate UL listed electrical wire clamp through each motor box electrical opening on top of the hood. Pre-install electrical wiring from the service panel to the hood location for each motor box. Consult the connection diagrams (on previous page) for further details on electrical placement.

**Method 1:** Extend wire to the hood. Electrical hook up will occur before the hood is installed on the wall.

**Method 2:** Extend wire to 24" above the countertop. Electrical hook up will occur after the hood is installed on the wall.

Model	Type	Volts	Amps	HZ	RPM	CFM SP@0"	Equivalent CFM	CFM SP@0.1"	CFM SP@0.2"	CFM SP@0.3"	Minimum Round Duct Size	Square Inches
B100 Single	Shaded Pole	115	1.7•	60	1550	300	450	286	270	240	6" (or equivalent)	28
B200 Dual	(2) Shaded Pole	115	3.4•	60	1550	600	900	572	540	480	8" (or equivalent)	50

●Note: Add .5 amp for each halogen bulb. Equivalent CFM refers to the fact that the Magic Lung blower uses centrifugal filtration units, whereas others use conventional filters. Apply this guideline when comparing blower units made by other manufacturers.

- 9) Measure on the wall where the top of the horizontal edge of the hood will be and mark the wall with a level horizontal line. Measure where the center (left to right) of the hood will be and mark the horizontal line on the wall with a short vertical centerline. Note: Be sure to leave enough space for the duct cover between the top of the hood and the ceiling.
- 10) Remove the screws inside the top of the back of the hood that retain the wood strip recessed in the mounting channel. Note: Some retaining screws may be located behind the blower(s). Remove the wood mounting strip from the back of the hood and place the top edge of the strip 1/8" below and parallel to the level horizontal mark on the wall. Referencing the vertical centerline in Step 9, place the mounting strip so it is centered on the wall in the space where the hood will be (left to right). Using proper hardware, attach the mounting strip to at least two wall studs. Drill pilot holes in the strip to prevent splitting.
- 11) FOR BACK VENTING APPLICATIONS ONLY. IF YOU ARE NOT BACK VENTING, PROCEED TO STEP 12. It is necessary to cut duct access hole(s) in the wall prior to installing the hood. To accomplish this, hold the hood on the mounting strip by aligning the channel at the top of the back of the hood over the wood mounting strip on the wall. Place the appropriate elbow(s) on top of the hood in line with the exhaust outlet collars. On the wall, trace around the elbow(s). Remove the hood and elbow(s) from the wall. Cut the wall around the outside of the traced line(s), avoiding wall studs. Install the duct from the outside of the home to the opening in the wall. Use duct tape to seal joints.
- 12) Hang the hood on the mounting strip by aligning the channel at the top of the back of the hood over the wood mounting strip on the wall. While holding the hood in place, mark locations on the mounting strip through the two mounting holes in the channel at the top of the hood. Some mounting holes may be located behind the blower(s). Remove the hood and drill 3/32" pilot holes at the center of the marks in the wood strip to prevent splitting.
- 13) FOR BACK VENTING APPLICATIONS ONLY. IF YOU ARE NOT BACK VENTING, PROCEED TO STEP 14.

Place the appropriate elbow(s) on the top of the hood. Elbow(s) should be placed inside the collar(s) of the exhaust outlet(s). Use duct tape to seal joints.

**Method 1:** Insert the electrical wire from the service panel through the electrical wire clamp on each motor box. Tighten the wire clamp(s). Place the duct cover over the top of the hood taking care to align the single flange on top of the hood between the double flange on the bottom of the duct cover. Press the duct cover down to engage the flanges. Lift hood up to wall and hang hood on mounting strip, taking care to properly align the duct connection between the hood and the wall.

## See Next Page For More Installation Details

## Installation Details Continued

- 13) (Continued) FOR BACK VENTING APPLICATIONS ONLY. IF YOU ARE NOT BACK VENTING, PROCEED TO STEP 14.

**Method 2:** Lift the hood up to the wall and hang the hood on the mounting strip, taking care to properly align the duct connection between the hood and the duct in the wall.

Secure the hood to the mounting strip by installing the screws (removed from the strip in Step 10) into the pilot holes drilled in Step 12.

**Method 1:** Secure the slack in the electrical wire.

**Method 2:** Insert the electrical wire from the service panel through the electrical wire clamp on each motor box. Tighten the wire clamp(s). Slide the duct cover between the ceiling and the top of the hood while aligning the flange on top of the hood between the double flange on the bottom of the duct cover. Gently slide the duct cover to the wall. Caution must be taken to avoid scratching the hood or ceiling.

**SKIP STEP 14. PROCEED DIRECTLY TO STEP 15.**

- 14) If applicable, install transition inside the exhaust collars and seal with duct tape.

**Method 1:** Insert the electrical wire from the service panel through the electrical wire clamp on each motor box. Tighten the wire clamp(s). Cut a piece of duct the length of the duct cover allowing room for transition on the top of the hood (if applicable). If a transition is used, cut the duct to reach the transition outlet plus 1". This will allow the transition to engage 1" inside of the duct. See Page 3 for transition height. One end of the duct must be crimped to fit inside the duct in the ceiling. Insert non-crimped end over the transition or into the exhaust collar on the top of the hood and seal with duct tape. Place the duct cover over the top of the hood taking care to align the single flange on top of the hood between the double flange on the bottom of the duct cover. Press the duct cover down to engage the flanges. Lift the hood into position while aligning the duct connection between the hood and the duct in the ceiling.

**Method 2:** Lift the hood up to the wall and hang the hood on the mounting strip, taking care to properly align duct work or transitions. Duct work and transitions must fit inside the exhaust collar. Use duct tape to seal all joints.

Secure the hood to the mounting strip by installing the screws (removed from the strip in Step 10) into the pilot holes drilled in Step 12.

**Method 1:** Secure the slack in the electrical wire.

**Method 2:** Insert the electrical wire from the service panel through the electrical wire clamp on each motor box. Tighten the wire clamp(s). Slide the duct cover between the ceiling and the top of the hood while aligning the flange on top of the hood between the double flange on the bottom of the duct cover. Gently slide the duct cover to the wall. Caution must be taken to avoid scratching the hood or ceiling.

- 15) Using UL listed wire nuts, attach the "neutral" wire(s) to the white lead(s), the "hot" wire(s) to the black lead(s), and the ground wire(s) to the green lead(s) inside the motor box(es).

**Warning: Do not operate hood without proper ground connection.**

- 16) Plug the motor(s) into the hood and reinstall the blower motor(s) using the three retaining screws that were removed in Step 7. Replace the blower housing(s) and the blower shield(s). Refer to the Owner Maintenance Guide Operating Instructions for proper hood operation. Test all blower and light functions to ensure they are operating properly.

**WALL LOUVER**

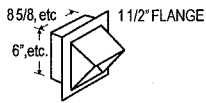

MODEL	DIM
VP526	6" RD
VP527	7" RD
VP528	8" RD
VP538	6"x8 1/2"

**WALL LOUVER**

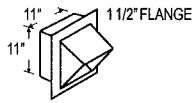

MODEL	DIM
VP554	10" RD

**WALL LOUVER**

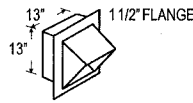

MODEL	DIM
VP555	12" RD

**WALL LOUVER**

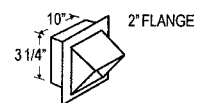

MODEL	DIM
VP560	3 1/4"x10"

**LOW PROFILE ROOF JACK (MAXIMUM 4/12 PITCH)**

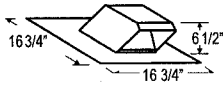

MODEL	DIM
VP539	6"
VP540	7"
VP541	8"

**LOW PROFILE ROOF JACK (MAXIMUM 4/12 PITCH)**



MODEL	DIM
VP552	10"
VP553	12"

**ADJUSTABLE ELBOW**

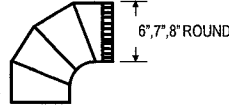

MODEL	DIM
VP513	6"
VP514	7"
VP515	8"

**BACK/SIDE VENT ELBOW**

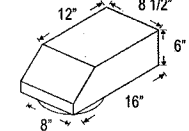

MODEL	DIM
VP561	8"-6" x 8 1/2"

**BACK VENT ELBOW**

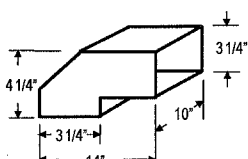

MODEL	DIM
VP559	3 1/4"x10"

**MULTI-BLOWER TRANSITION**

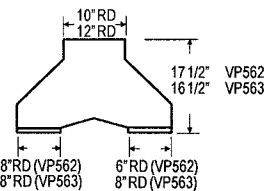

MODEL	DIM
VP562	10"
VP563	12"

**"Y" TRANSITION**

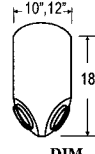

MODEL	DIM
VP517	8" x 8" - 12"
VP518	6" x 8" - 12"
VP551	6" x 8" - 10"

**10 TO 7 TRANSITION**

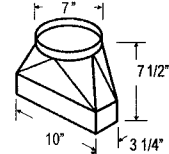

MODEL	DIM
VP521	3 1/4" x 10" - 7"

**OFFSET KIT-ROUND**

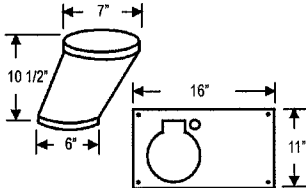

MODEL	DIM
VP529	6" TO 7"

**OFFSET KIT-RECTANGLE**

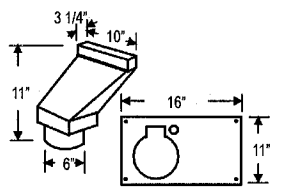

MODEL	DIM
VP550	6"-3 1/4"x10"

**STANDARD ISLAND TRANSITION**

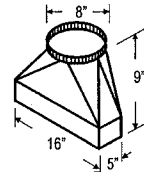

MODEL	DIM
VP565	

**CLUSTER BLOWER TRANSITION**

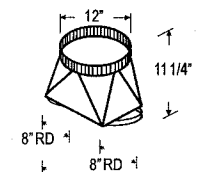

MODEL	DIM
VP564	

**OFFSET L & R TRANSITION FOR ISLAND BLOWERS**

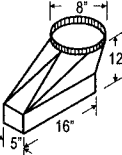

MODEL	DIM
VP542	TOP LEFT ISLAND
VP543	TOP RIGHT ISLAND

**SIDE VENT TRANSITION L & R FOR ISLAND HOODS**

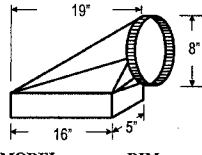

MODEL	DIM
VP544	LEFT SIDE
VP545	RIGHT SIDE

**ROUND COLLAR**

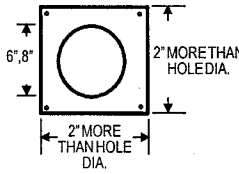

MODEL	DIM
VP533	6"
VP535	8"

**COLLAR, SQUARE**

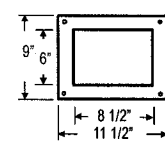

MODEL	DIM
VP537	6 x 8 1/2"

**ROUND DUCT**

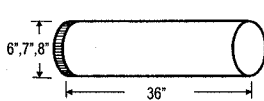

MODEL	DIM
VP500	6"
VP501	7"
VP502	8"

**3 1/4\"/>**

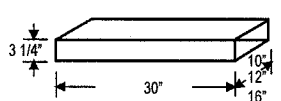

MODEL	DIM
VP504	3 1/4" x 10"
VP505	3 1/4" x 12"
VP506	3 1/4" x 16"

**6\"/>**

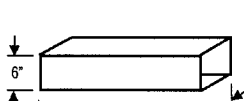

MODEL	DIM
VP507	6" x 8 1/2"