



Performance

- Three fan speeds
- Dimmer lighting - for a soft lighting effect
- Dishwasher safe stainless steel baffle filters
- Dishwasher safe grease collection trays are easily removed
- Filter systems are highly efficient at capturing grease
- Vertical ducting direction
- 1000 CFM Internal Blower included
- Hood includes filters, backdraft damper and transition
- 10" Round duct size

Design

- 24" depth hood is 18" tall and a perfect companion with Pro Ranges and Rangetops
- Chiseled design for a seamless integration into any kitchen
- Halogen lighting spotlights your best recipes
- Brushed stainless steel finish
- Stainless steel control buttons
- Stainless steel duct covers available as an accessory
- Thermador Professional Series Chimney style wall hoods impart a more contemporary feel to the kitchen space and create a dramatic gathering point.
- Delayed shut-off tackles lingering odors for up to ten minutes
- Auto function senses the heat from the cooking surface and adjusts the fan speeds
- Built-in 'Clean Filter' reminder light illuminates after 40 hours of operation
- Powerfully Quiet ventilation system 3.8 Sones / 327 CFM Low to 11.8 Sones / 1000 CFM High

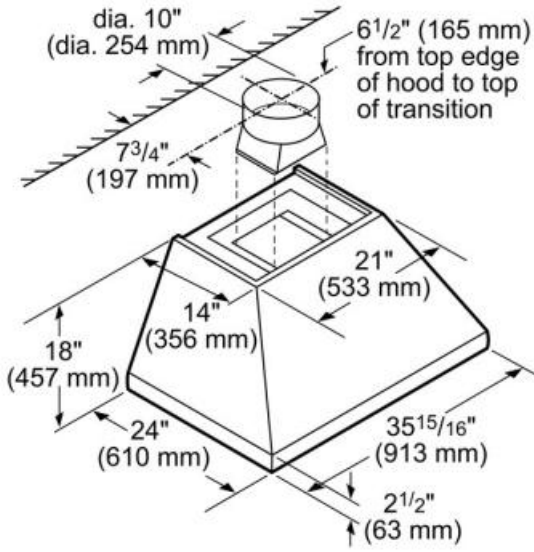

Amps (A)	15
Frequency (Hz)	60
Approval certificates	CSA
Plug type	no plug
Net weight (lbs)	44
Gross weight (lbs)	49
Required distance above range/rangetop/cooktop	30"/30"
Motor location	Integrated motor in hood body
Diameter of air duct (in) top	10
Operating mode	Ducted
Delay shut off modes	10
Required accessories	Blower
Optional accessories	CHMHP3612N, CHMHP366N, CHMHP36TSN, KHS36QS, PA36JBS, RFPLT1000, RFPLT600, RJ310, WC10
Number of lights	2
Type of lamps used	Halogen
Total power of the lamps (W)	40
Grease filter material	Washable stainless steel