BERTAZZONI PROFESSIONAL SERIES

36" UNDERMOUNT CANOPY HOOD KU36 PRO 2 X



These powerful canopy hoods have dual motors delivering a combined 1200 CFM of extraction. They match Bertazzoni Professional Series ranges and cooktops while also complementing other Bertazzoni Series. They can be installed under a cabinet or on the wall, with optional medium or full-width duct covers. Stainless-steel baffle filters can be easily removed and are dishwasher safe.

DOUBLE MOTOR CANOPY



Double motor canopy hood shown with optional medium duct cover. Full-width duct cover is also available.



TO COOK BEAUTIFULLY

BERTAZZONI PROFESSIONAL SERIES

36" UNDERMOUNT CANOPY HOOD KU36 PRO 2 X

FEATURES

Hood finishing	stainless steel
Motor	2
Speed	3
Hood control	electronic with buttons
Halogen lights	4
Filters	baffle stainless steel
Max extraction power	1200 cfm

TECHNICAL SPECIFICATIONS

Electrical Requirements	120 V 60 Hz
Max Amp usage, power rating	6.6 A - 800 W
Certification	cETLus
Warranty	2 years parts and labor

ACCESSORIES

Medium duct cover	code 901263
Full-width duct cover	code 901265
Air Bracket	code 901264

This model is not suited for recirculation

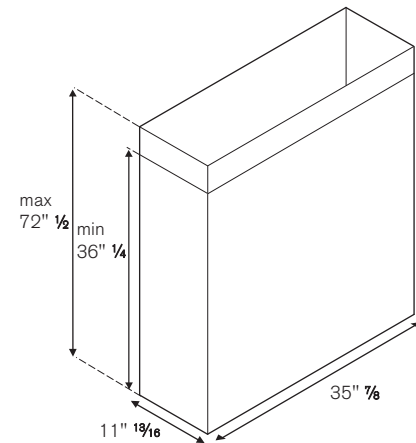
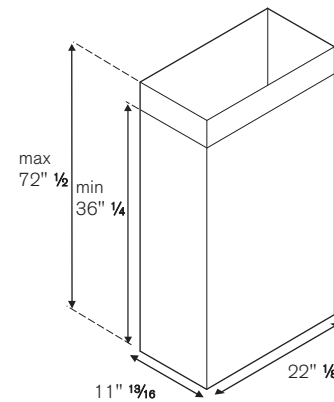
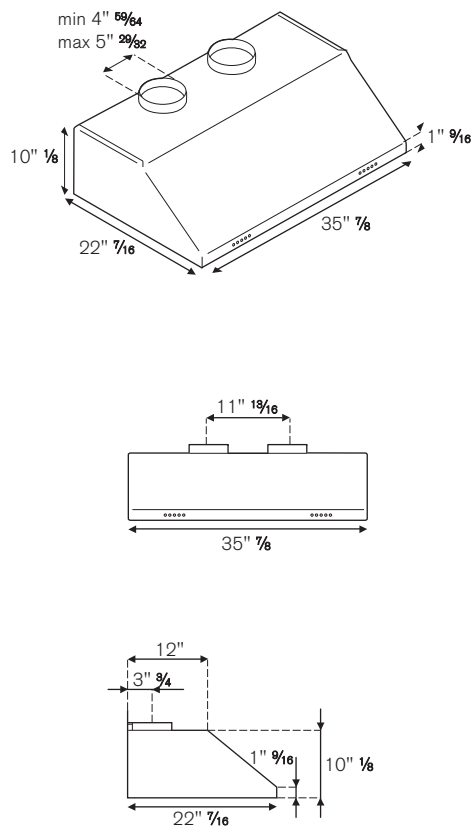

INSTALLATION INSTRUCTIONS

Bertazzoni recommends to operate the appliance after it has been properly installed. Please refer to the installation manual for further details.

Disclaimer: while every effort has been made to insure the accuracy of the information contained in this brochure, Fratelli Bertazzoni reserves the right to change any part of the information at any time without notice.

Fratelli Bertazzoni, Bertazzoni and the winged wheel brand icon are registered trademarks of Bertazzoni Spa.