

HPCB36NS

36-INCH CHIMNEY WALL HOOD WITH BLOWER

PROFESSIONAL SERIES



FEATURES & BENEFITS

- 1,000 CFM Integrated Blower included
- Three fan speeds
- Dimmer lighting – for a soft lighting effect
- Commercial-Style Stainless Steel Baffle Filter
- Filter systems are highly efficient at capturing grease
- Auto function senses heat from the cooking surface and adjusts fan speeds
- Built-in 'Clean Filter' reminder light illuminates after 40 hours of operation
- Delayed shut-off tackles lingering odors for up to 10 minutes

ACCESSORIES (OPTIONAL)

6" High Duct Cover	CHMHP366N
12" High Duct Cover	CHMHP3612N
18" - 35" High Duct Cover	CHMHP36TSN

GENERAL PROPERTIES

Operating Mode	Ducted
Maximum CFM	1,000 CFM
Sones	12.0 HS / 4.0 WS
Number of Speed Settings	3-Stage
Motor Location	Integrated Motor In Hood Body
Number of Lights	2
Bulb Type	Halogen
Total Power of the Lamps (W)	40 W
Damper Included	Yes
Grease Filter Material	Washable Stainless Steel
Grease Filter Type	Commercial-Style Stainless Steel Baffle Filter

TECHNICAL DETAILS

Watts (W)	N/A
Current (A)	15 A
Volts (V)	120 V
Frequency (Hz)	60 Hz
Plug Type	Fixed Connection, No Plug
Conduit Length	N/A

DIMENSIONS & WEIGHT

Overall Appliance Dimensions (Width of Canopy Included) (HxWxD) (in)	18" x 35 ¹⁵ / ₁₆ " x 24"
Height of The Chimney (in)	Duct Covers Sold Separately
Required Distance Above Cooktop / Range Cooking Surface	30" / 30"
Diameter of Air Duct (in) Top	10"
Net Weight (lbs)	91 lbs

BLOWER OPTIONS

Remote Blower (Mounted to Roof or External Wall)	N/A
	N/A
	N/A
Inline Blower (Mounted Between Kitchen and External Wall)	N/A
	N/A
Integrated Blower (Mounted in Hood)	N/A

WARRANTY

Limited Warranty Parts and Labor	2 Year
----------------------------------	--------

HPCB36NS

36-INCH CHIMNEY WALL HOOD WITH BLOWER

PROFESSIONAL SERIES



HOOD DIMENSIONS

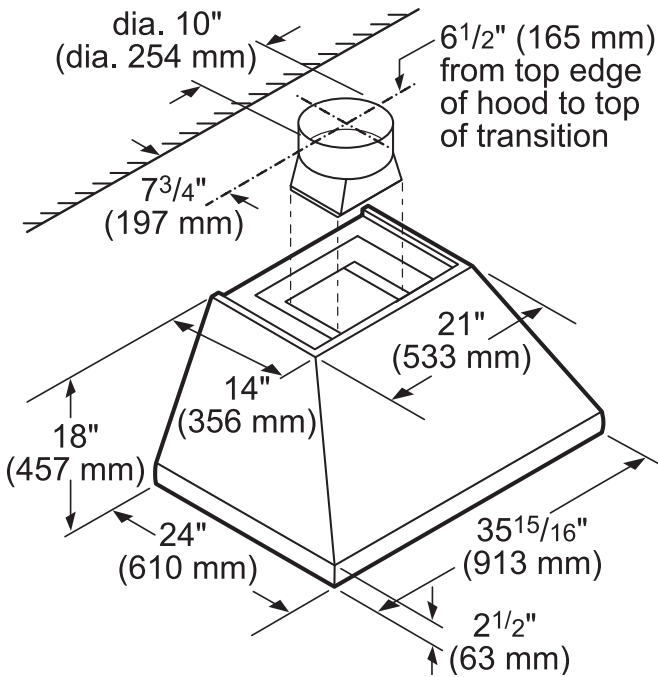

OPTIONAL ACCESSORIES

6" HIGH DUCT COVER CHMHP366N

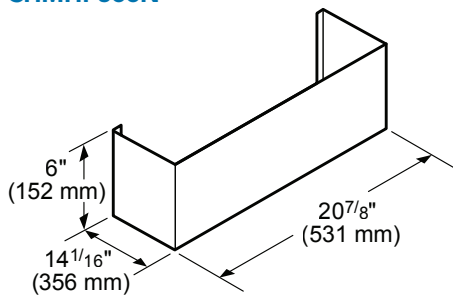

12" HIGH DUCT COVER CHMHP3612N

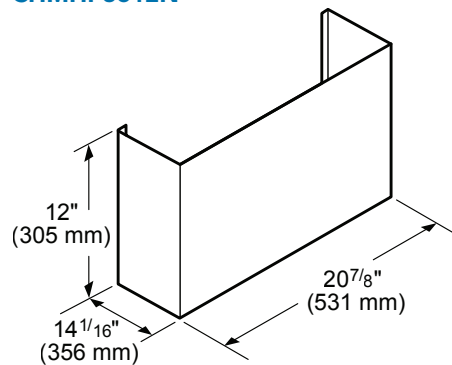

18" - 35" HIGH DUCT COVER CHMHP36TSN

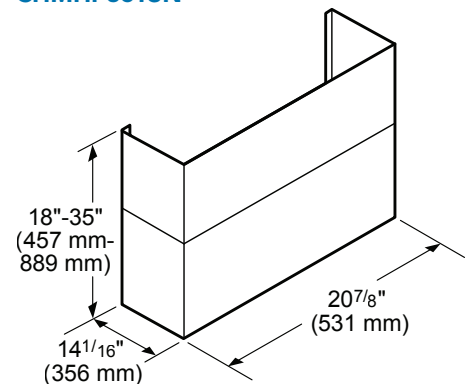

These warranties give you specific legal rights and you may have other rights that vary from state to state. Full warranty and limited warranty from date of installation. For complete warranty details, refer to your Use & Care manual, or ask your dealer.

Specifications are for planning purposes only. Refer to installation instructions and consult your countertop supplier prior to making counter opening. Consult with a heating and ventilation engineer for your specific ventilation requirements. For the most detailed information, refer to installation instructions accompanying product or write to Thermador indicating the model number. Specifications are correct at time of printing. Thermador reserves the right to change product specifications or design without notice. Some models are certified for use in Canada. Thermador is not responsible for products that are transported from the U.S. for use in Canada.