

HDDB36WS

36-INCH CHIMNEY WALL DRAWER HOOD

MASTERPIECE® SERIES



FEATURES & BENEFITS

- Pull canopy open for increased capture, or push back for flush design
- ★ - Noise Control Deluxe™ drastically reduces noise while hood is in use
- ★ - Equipped with the Thermador Connected Experience by Home Connect™
 - Cooktop Hood Sync enables control through Freedom® Induction Cooktop
 - Beautiful illumination with multi-level, vivid LED lights

ACCESSORIES (OPTIONAL)

Stainless Steel Chimney Hood Extension

CHXTHDDW - For up to 12-foot ceiling applications. Extension replaces upper section of standard chimney extension.

Recirculation Kit

RECHDDB - For HDDBxxWS Masterpiece® Chimney Wall Drawer Hoods only

Replacement Charcoal Filter

CHFHMCD - For use with recirculation kit RECHDDB

Remote Control Panel

REMCPU - Ability to vertically install on cabinetry or wall to control hood in a convenient location

8" Wall Cap

WC8



GENERAL PROPERTIES

Features

Cooktop Hood-Sync Enabled, Noise Control Deluxe™, Multi-Level LED Lights with Fading Transitions, Automatic Mode, Check Filter Reminder Light, Delay Shut-Off

Operating Mode	Convertible: Ducted / Recirculating
Maximum CFM	600 CFM
Sones*	1.4
Number of Speed Settings	4-Stage
Motor Location	Integrated Motor In Hood Body
Number of Lights	2
Bulb Type	LED
Total Power of the Lamps (W)	2.4 W
Damper Included	Yes
Grease Filter Material	Washable Stainless Steel
Grease Filter Type	Hybrid Mesh
Home Connect™ (Wi-Fi Enabled)	Yes

TECHNICAL DETAILS

Watts (W)	476 W
Current (A)	15 A
Volts (V)	120 V
Frequency (Hz)	60 Hz
Plug Type	3 Prong
Conduit Length	60"

DIMENSIONS & WEIGHT

Overall Appliance Dimensions (Width of Canopy Included) (HxWxD) (in)	30" – 42" x 35 15/16" x 18 3/16"
Height of the Chimney (in)	26 3/4" – 38 3/4"
Accommodates Ceiling Heights	Up to 9' Ceiling Heights
Required Distance Above Cooktop / Range Cooking Surface	30" / 30"
Diameter of Air Duct (in) Top	8"
Net Weight (lbs)	12 lbs

WARRANTY

Limited Warranty Parts and Labor	2 Year
----------------------------------	--------

*Measured at Speed 1 in ducted installation

HDDB36WS

36-INCH CHIMNEY WALL DRAWER HOOD

MASTERPIECE® SERIES



HOOD DIMENSIONS

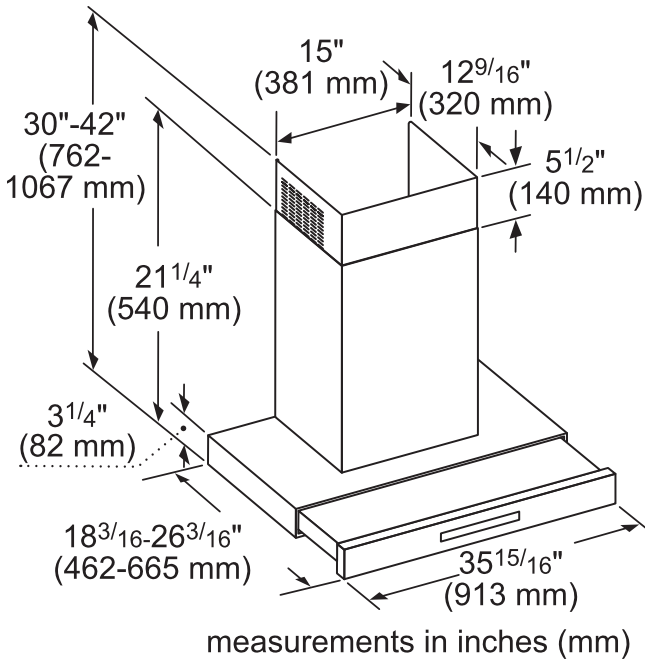

OPTIONAL ACCESSORIES

CHIMNEY EXTENSION KIT CHXTHDDW

Telescoping design for extension up to 12' ceiling heights

RECIRCULATION KIT RECHDDB

Ideal for applications where ducting out is not possible

REPLACEMENT CHARCOAL FILTERS CHFHMCD

For Use With Recirculation Kit RECHDDB

REMOTE CONTROL PANEL REMCPU

Convenience at your fingertips: The remote control accessory offers the freedom to extend your hood controls to a more reachable spot

HDDB36WS

36-INCH CHIMNEY WALL DRAWER HOOD

MASTERPIECE® SERIES



WALL CAPS

8-INCH WALL CAP-WC8

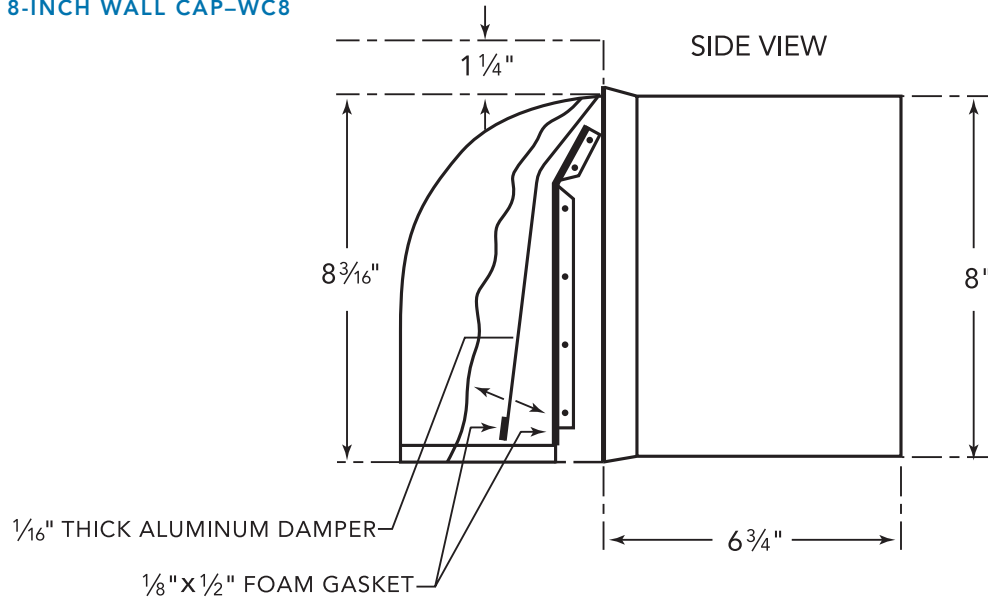

These warranties give you specific legal rights and you may have other rights that vary from state to state. Full warranty and limited warranty from date of installation. For complete warranty details, refer to your Use & Care manual, or ask your dealer.

Specifications are for planning purposes only. Refer to installation instructions and consult your countertop supplier prior to making counter opening. Consult with a heating and ventilation engineer for your specific ventilation requirements. For the most detailed information, refer to installation instructions accompanying product or write to Thermador indicating the model number. Specifications are correct at time of printing. Thermador reserves the right to change product specifications or design without notice. Some models are certified for use in Canada. Thermador is not responsible for products that are transported from the U.S. for use in Canada.