

BUILT-IN EXTENDED HEIGHT GRILLE  
**INSTALLATION GUIDE**

---

SPECIFICATIONS, INSTALLATION, AND MORE

---



## Contents

- 3 Built-In Extended Height Grille
- 4 Air Flow Requirements
- 5 Functional Panel
- 6 Grille Hinging System

Features and specifications are subject to change at any time without notice. Visit [subzero.com/specs](http://subzero.com/specs) for the most up-to-date information.

## Important Note

To ensure this product is installed and operated as safely and efficiently as possible, take note of the following types of highlighted information throughout this guide:

**IMPORTANT NOTE** highlights information that is especially important.

**CAUTION** indicates a situation where minor injury or product damage may occur if instructions are not followed.

**WARNING** states a hazard that may cause serious injury or death if precautions are not followed.

**IMPORTANT NOTE:** Throughout this guide, dimensions in parentheses are millimeters unless otherwise specified.

## Built-In Extended Height Grille

### ▲ WARNING

This design feature involves potentially hazardous elements consisting of large, heavy panels located overhead. It is the responsibility of the designer to specify panel support components suitable for this use and the installer to use proper workmanship during construction. Sub-Zero cannot be liable for custom applications beyond its control.

### FLUSH INSET

All built-in flush inset models have the option of extending the height of the decorative grille panel. This application is used when the kitchen design calls for a decorative panel taller than the standard grille for an 84" (2134) finished height or the optional grille for an 88" (2235) finished height. With an extended height grille panel, the finished height of the unit can be 88" (2235) or more to match surrounding cabinetry.

The decorative grille panel and support hinges are provided by the customer. The factory-supplied grille frame is fitted with a functional panel that serves as an air baffle. The grille frame also acts as a support to hold the decorative panel open for condenser cleaning, water filter replacement, and service.

The decorative panel and grille frame are supported by two separate hinge systems and are only connected by a cleat when open and a catch when closed.

### FLUSH INSET PANELS

The flush inset design allows for custom grille and door panels to be completely flush, blending more seamlessly with surrounding cabinetry.



Flush inset panels.

### Air Flow Requirements

Allow for at least 1/2" (13) space on all four sides of the grille panel for proper air flow to the refrigeration system. For flush inset models, this is around the sides, top and bottom of the decorative grille panel. Refer to the illustration below.

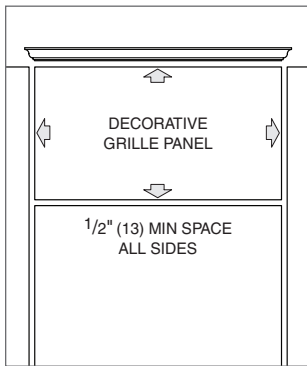

Air flow.

Space must be maintained between the decorative grille panel and surrounding cabinetry for air flow. Refer to the illustrations below.

**IMPORTANT NOTE:** If space is not provided directly above the top of the grille panel, it must be provided above the upper molding of the elevation as shown in the illustration below.

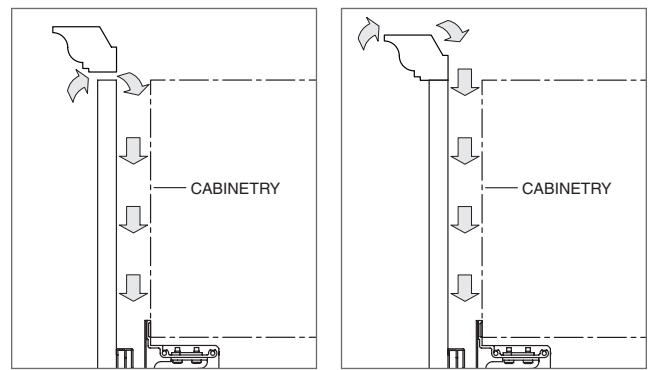

Air flow above grille panel.

Air flow above molding.

## Functional Panel

A 1/4" (6) thick functional panel must be installed in the inner grille frame (the part that flips up) to prevent warm air discharge from short-circuiting back into the system. Refer to the illustration below.

Use sizing for the “backer panel” found in the panel configurator or Sub-Zero design guide. Visit our website, [subzero.com](http://subzero.com).

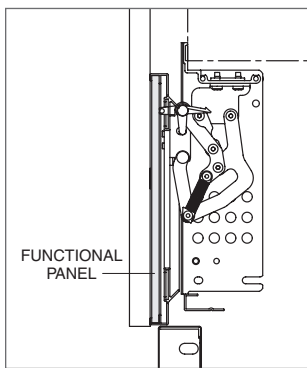

Functional panel (side view).

## Grille Hinging System

### HINGING SYSTEM

Specify the customer-supplied hinging system consistent with cabinetry and with sufficient capacity to support the weight of the decorative grille panel. Refer to the illustration below.

**IMPORTANT NOTE:** If refrigeration components must be removed for service, the standard grille frame will need to be removed first for sufficient access to the machine compartment. To avoid an unsupported load, the decorative panel will need to be removed from the cabinetry first.

### CLEAT

Field install a cleat to the back side of the decorative grille panel to hold the flip-up inner grille frame in position when raised. Follow dimensions in the inset illustration below for the 10" (254) long cleat. For location of the cleat, also refer to the illustration on the following page. For a dual installation, use two cleats.

#### ⚠ CAUTION

The cleat must include a lip as shown, to prevent unintentional separation of the decorative panel and grill frame.

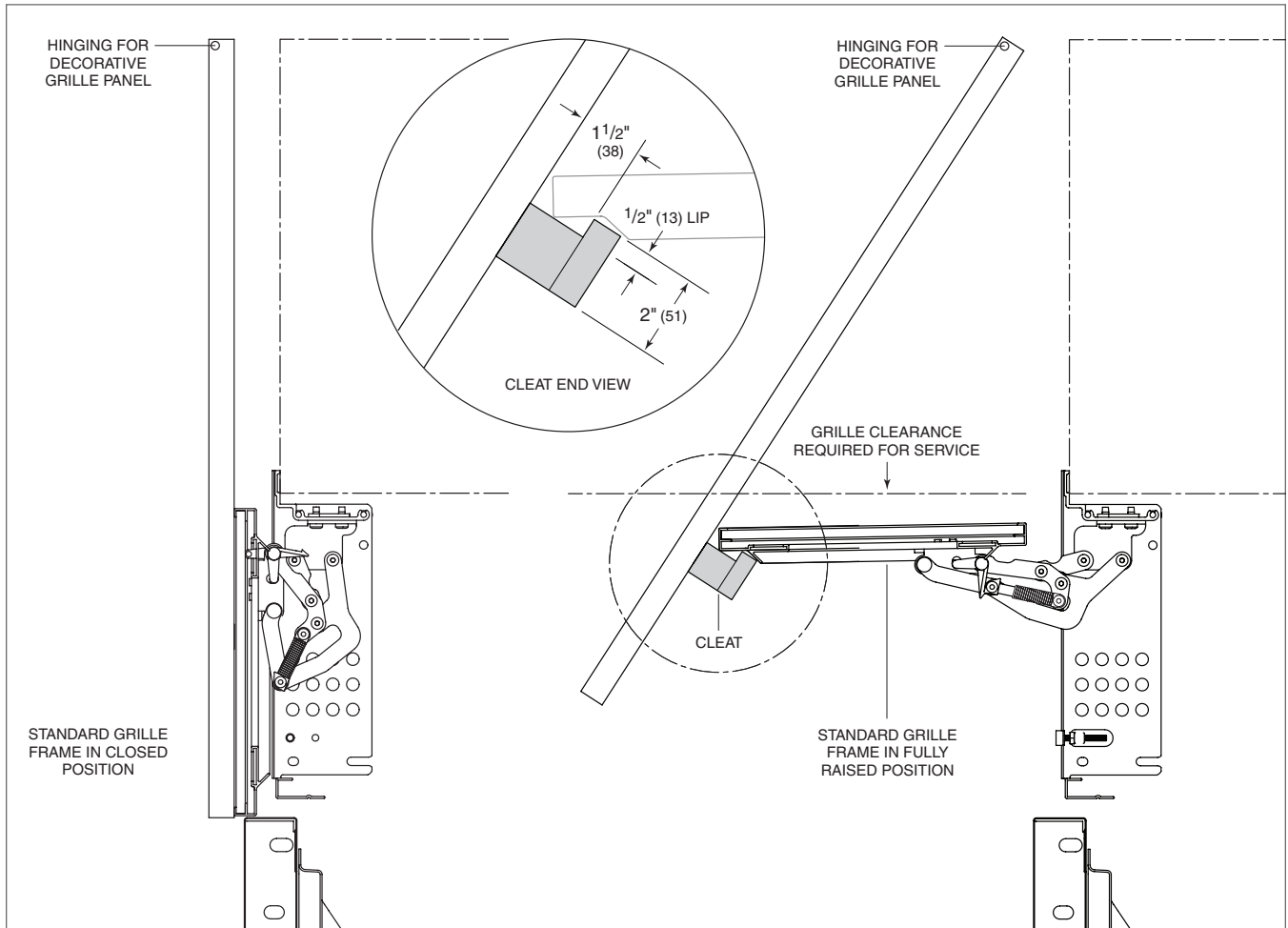

Grille hinging system (side view).

## Grille Hinging System

### INSTALL CLEAT AND CATCH

The cleat must be located to the left of a line 3" (76) to the right of the center of the built-in unit to clear the system fan shroud. Refer to the illustration below.

Cut a rectangular clearance hole in the functional grille panel to allow the cleat to extend through when the decorative grille panel is closed.

Install a customer-supplied catch between the back of the decorative grille panel and the functional grille panel to prevent noise caused by vibration.

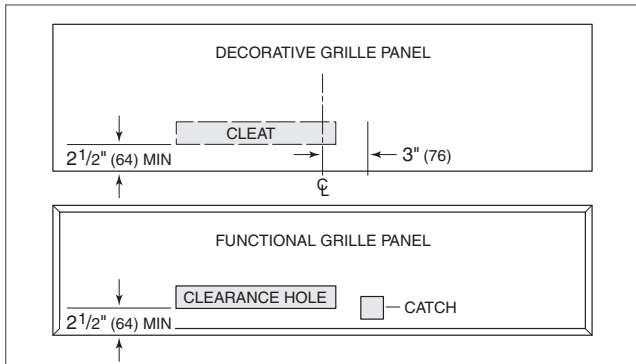

Install cleat and catch.

Depending on the design and size of the catch, it will need to be recessed into the functional grille panel and possibly partially into the decorative grille panel.

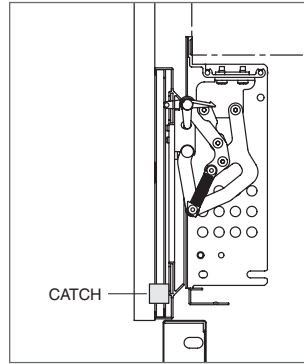

Catch (side view).

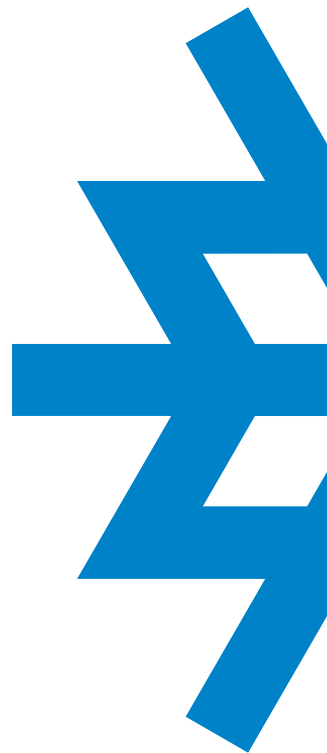

SUB-ZERO, INC. P.O. BOX 44848 MADISON, WI 53744 SUBZERO.COM 800.222.7820

000000 REV-A

5/2018

