BERTAZZONI MASTER SERIES

36" DROP-IN LOW PROFILE COOKTOPS

QB36M 5 00 X

HIGHLIGHTS

- Bertazzoni's exclusive dual control power burner in cast brass delivers high-efficiency performance from delicate low simmer to full power (750 – 18,000 BTUs) with best-in-class heat-up time.
- Cast iron pan supports of exclusive design allow sliding of cookware across the entire cooking surface. The stainless steel worktop is also seamless for easy cleaning and the sharpest look.
- Bertazzoni low profile drop-in cooktops sit almost flush over the countertop and present a seamless edge all around. The design integrates beautifully with the Bertazzoni line of convection ovens, specialty ovens and warming drawers.
- The one-touch, child safety ignition system lets you light and adjust burners with one hand.
- The thermocouple safety system automatically stops the gas flow if the flame goes out, even when electrical power is cut.



FEATURES

Brass burners	5
Dual wok	(1x) 750-18000 Btu/h
Rapid	(1x) 11000 Btu/h
Semi-rapid	(2x) 6500 Btu/h
Auxiliary	(1x) 3400 Btu/h
Simmer rate	750 Btu/h
Maintop	stainless steel
Controls	soft touch round knobs
Grates	cast iron
Wok adapter	yes
Simmer ring	yes

TECHNICAL SPECIFICATIONS

Electrical Requirements	120 V 60 Hz
Max Amp usage, power rating	0,1 A - 10 W
Certification	CSA
Warranty	2 years parts and labor

ACCESSORIES

Stainless steel griddle for gas burners code SG36X

A LP conversion kit for all burners is included



TO COOK BEAUTIFULLY
WWW.BERTAZZONI.COM

INSTALLATION INSTRUCTIONS

QB36M 5 00 X

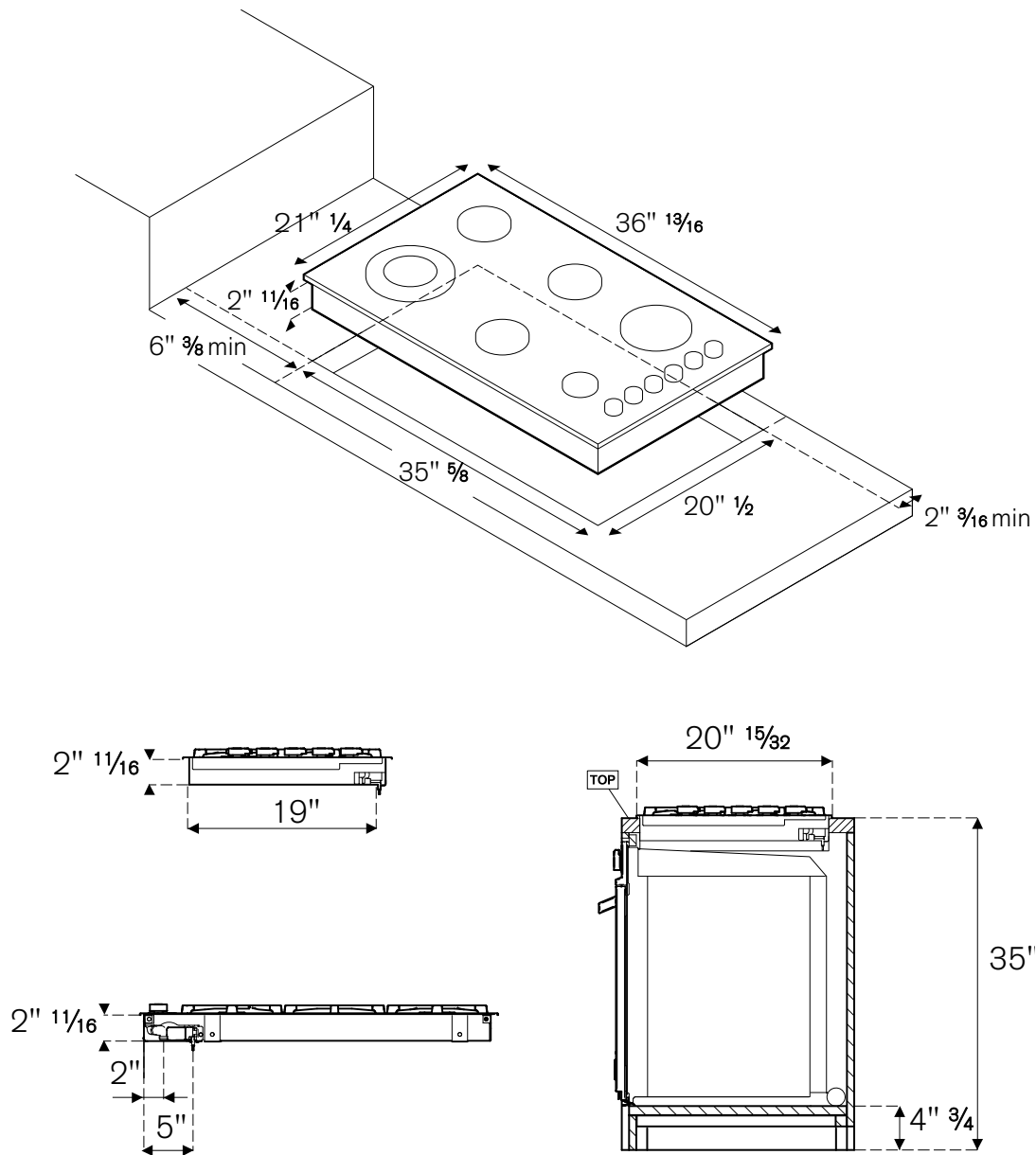

Bertazzoni recommends to operate the appliance after it has been installed in a cabinet.

The kitchen cabinets shall be made of materials capable of withstanding temperatures at least 117°F (65°C) above room temperature in order to avoid possible damage to the cabinets during appliance usage.

Disclaimer: while every effort has been made to insure the accuracy of the information contained in this brochure, Fratelli Bertazzoni reserves the right to change any part of the information at any time without notice.

Fratelli Bertazzoni, Bertazzoni and the winged wheel brand icon are registered trademarks of Bertazzoni Spa.