

WD30JS

30-INCH TRADITIONAL WARMING DRAWER

MASTERPIECE® SERIES HANDLE



FEATURES & BENEFITS

- ★ - SoftClose® hinges for ultra smooth closing of the warming drawer
- Telescopic ball-bearing rails offer smooth handling and support up to 40 lbs
- Warming Mode with three convenient temperature settings
- Special Proof Mode
- Moisture selector controls humidity level in the drawer

GENERAL PROPERTIES

Power Levels	High, Low, Medium
Dough Proofing Mode	Yes
Plate Warming Mode (for multiple plates)	No
Warming Mode	Yes
Temperature Settings	F140 - F165 - F190 (Proof: F100)
Timer	Yes
Automatic Shut Off After 1 Hour	Yes
Door Opening	Pull Handle
Hinges	SoftClose®
Wattage Heating Element(s)	450 W
Easy-Clean Glass Ceramic Surface	No
Control Type	Touch Control With Blue Digital Display

CAPACITY

Cavity Capacity (cu. ft.)	2.6 cu. ft.
Holds Up To __ Dinner Plates	27

TECHNICAL DETAILS

Watts (W)	450 W
Circuit Breaker (A)	15 A
Volts (V)	120 V
Frequency (Hz)	60 Hz
Power Cord Length (in)	84"
Plug Type	120V 3-Wire

DIMENSIONS & WEIGHT

Overall Appliance Dimensions (HxWxD) (in)	11 1/4" x 29 3/4" x 23 7/8"
Required Cutout Size (HxWxD) (in)	11" x 28 1/2" x 23 3/8"
Net Weight (lbs)	80 lbs

WARRANTY

Limited Warranty Parts and Labor	2 Year
----------------------------------	--------

WD30JS
30-INCH TRADITIONAL WARMING DRAWER
 MASTERPIECE® SERIES HANDLE



30-INCH TRADITIONAL WARMING DRAWER AND CUTOUT DIMENSIONS

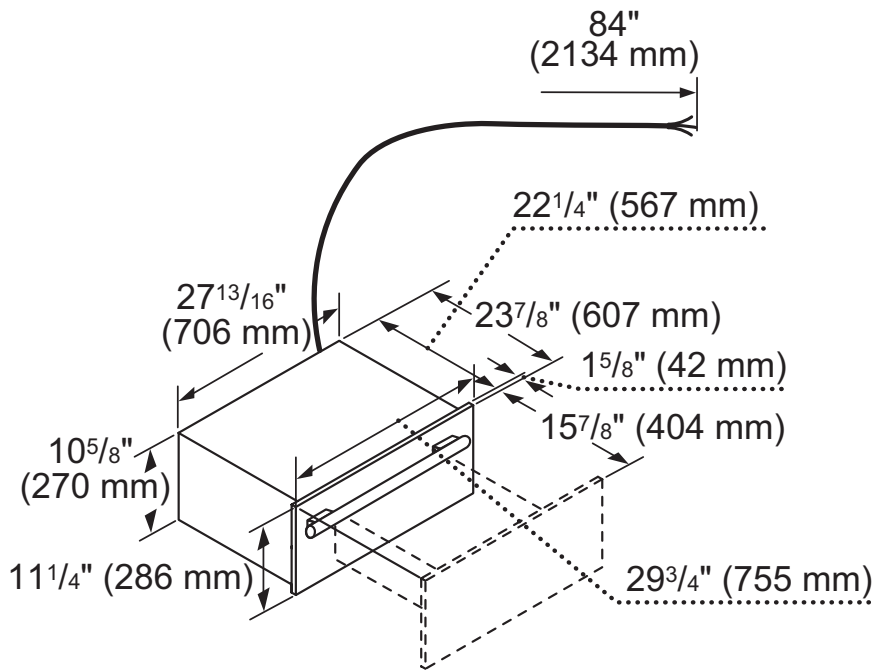
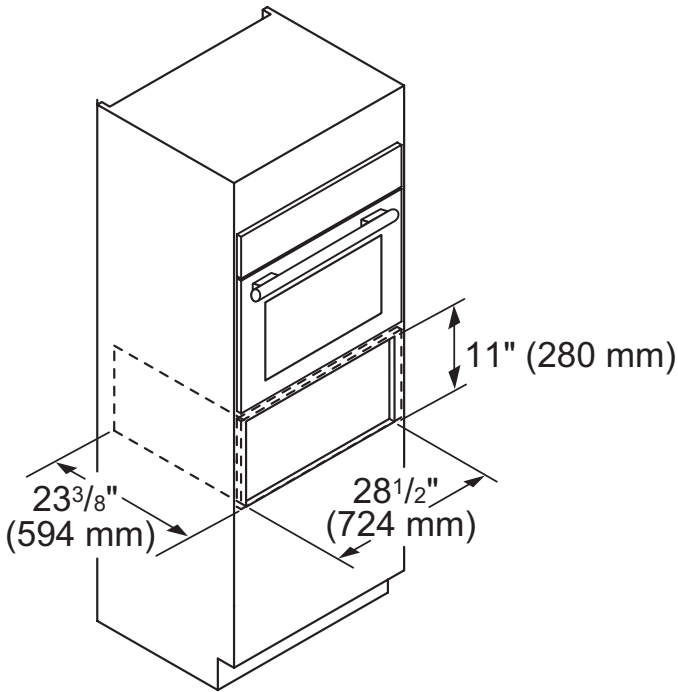

Door Handle Depth*

Masterpiece
Handle

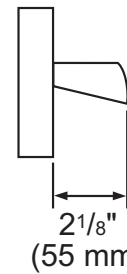

*Protrusion of handle from outer part of drawer front. Does not include thickness of drawer front

These warranties give you specific legal rights and you may have other rights that vary from state to state. Full warranty and limited warranty from date of installation. For complete warranty details, refer to your Use & Care manual, or ask your dealer.

Specifications are for planning purposes only. Refer to installation instructions and consult your countertop supplier prior to making counter opening. Consult with a heating and ventilation engineer for your specific ventilation requirements. For the most detailed information, refer to installation instructions accompanying product or write to Thermador indicating the model number. Specifications are correct at time of printing. Thermador reserves the right to change product specifications or design without notice. Some models are certified for use in Canada. Thermador is not responsible for products that are transported from the U.S. for use in Canada.