



30" Wall Mount Range Hood

WVW51UC0F



Stainless Steel
WVW51UC0FS

General Features & Properties

Convertible Ventilation (Recirculating or Vented)

44 dBA (.7 Sones) at Low Speed

Electrical Details

Amps	15
Volts	120

Technical Details

Blower Power	Centrifugal
Hood Type	Wall Canopy
CFMs	400
Lighting Type	LED
Number of Speeds	3
Venting Type	Exterior or Recirculating

Dimensions

Product Dimensions (H x W x D)	28-7/8" x 30" x 20"
--------------------------------	---------------------------

Reference Material

[Dimension Guide](#)

[Install Guide](#)

[Use & Care Guide](#)

[Warranty](#)

Key Features & Benefits

LED Task Lighting

Bright, long-lasting LED task lighting makes it easy to see what you're cooking.

Grease Filter

The grease filter helps trap unwanted grease and helps remove odors.

3-Speed, 400 CFM Motor Class

Three fan speeds provide the right amount of ventilation for every meal you prepare.

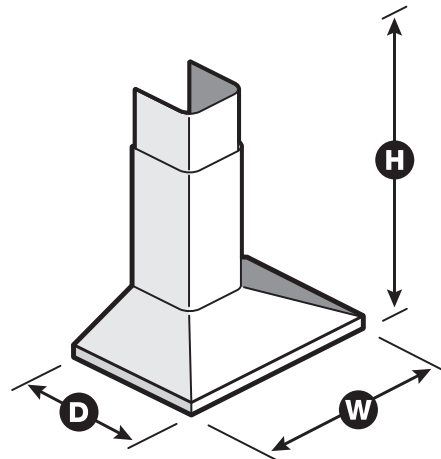

NOTE: Dimensions are for planning purposes only. For complete details, see Installation Instructions packed with product. Specifications subject to change without notice.

®/™ © 2020. All rights reserved. Printed in the U.S.A. D200104XXE. WVW51UC0FSpecSheetV01.