



# 21 cu. ft. Side-by-Side Refrigerator

## WRS331SDH



Monochromatic Stainless Steel  
WRS331SDHM

### Also available in:



White

**WRS331SDHW**



Black

**WRS331SDHB**

### Capacity

Total Capacity	21 cu. ft.
Refrigerator Capacity	14 cu. ft.
Freezer Capacity	7 cu. ft.

### General Features & Properties

ENERGY STAR® Certified

Exterior Ice and Water Dispenser with EveryDrop® Water Filtration

Tap Touch Controls

Hidden Hinges

Electronic Temperature Controls

Factory-Installed Ice Maker

Adaptive Defrost

LED Dispenser Night-Light

Humidity-Controlled Crispers

### Electrical Details

Amps	10
Volts	120

### Certifications

ADA Compliant	Yes
ENERGY STAR® Certified	Yes

### Technical Details

Refrigerator Type	Side-by-Side
Number of Doors	2
Number of Interior Refrigerator Shelves	4
Number of Refrigerator Door Bins	2 Fixed, 3 Adjustable
Number of Interior Freezer Shelves	3
Number of Freezer Door Bins	4 Fixed
Lighting Type	LED
Ice Maker	Factory Installed
Ice Maker Location	Freezer
Dispenser Type	Exterior Ice and Water

### Dimensions

Product Dimensions (H x W x D)	66-5/8" x 32-3/4" x 33-5/8"
Depth with Door Open 90°	49-5/16"
Cutout Dimensions	Allow extra 1/2" on sides and top Allow extra 1" on rear

### Reference Material

[Dimension Guide](#)

[Install Guide](#)

[Energy Guide](#)

[Warranty](#)

### Key Features & Benefits

#### Frameless Glass Shelves

Store more items on each shelf with wall-to-wall frameless glass shelves, which offer greater storage flexibility.

#### Adjustable Gallon Door Bins

Move these adjustable bins anywhere in the door for increased loading flexibility when and where you need it.

#### LED Interior Lighting

Keep food looking as good as it tastes. Light is cast inside the refrigerator so food looks like it's supposed to.

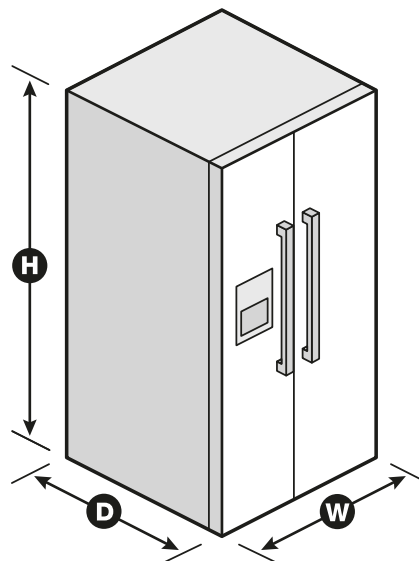

NOTE: Dimensions are for planning purposes only. For complete details, see Installation Instructions packed with product. Specifications subject to change without notice.

®/™ © 2020. All rights reserved. Printed in the U.S.A. D200052XXC. WRS331SDHSPECSHEETV01.