



# 30" Wall Mount Range Hood

WVW53UC0F



Stainless Steel  
WVW53UC0FS

## General Features & Properties

Convertible Ventilation (Recirculating or Vented)

44 dBA (.7 Sones) at Low Speed

## Electrical Details

Amps	15
Volts	120

## Technical Details

Blower Power	Centrifugal
Hood Type	Wall Canopy
CFMs	400
Lighting Type	LED
Number of Speeds	3
Venting Type	Exterior or Recirculating

## Dimensions

Product Dimensions (H x W x D)	28-7/8" x 30" x 20"
--------------------------------	---------------------------

## Reference Material

[Dimension Guide](#)

[Install Guide](#)

[Use & Care Guide](#)

[Warranty](#)

## Key Features & Benefits

### LED Task Lighting

Bright, long-lasting LED task lighting makes it easy to see what you're cooking.

### Grease Filter

The grease filter helps trap unwanted grease and helps remove odors.

### 3-Speed, 400 CFM Motor Class

Three fan speeds provide the right amount of ventilation for every meal you prepare.

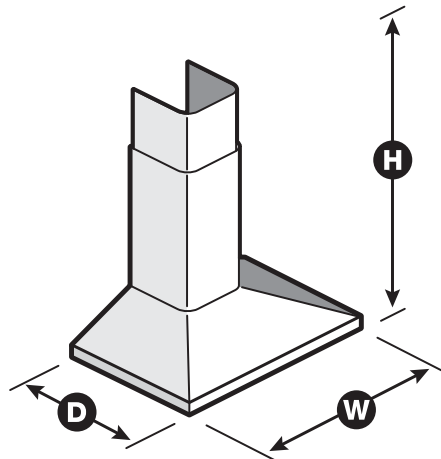

NOTE: Dimensions are for planning purposes only. For complete details, see Installation Instructions packed with product. Specifications subject to change without notice.

®/™ © 2020. All rights reserved. Printed in the U.S.A. D200104XXE. WVW53UC0FSpecSheetV01.