

Integrated Double DishDrawer™ Dishwasher, Tall, Sanitize

series 11 | Integrated

Panel Ready



Integrates seamlessly into kitchen cabinetry. Each drawer features a premium stainless steel interior and operates independently, for flexible washing.

- Eight wash cycles from Heavy to Light, including Auto, 60min and Glassware
- Tall top drawer fits full-size dinner plates up to 12 1/4 inches, with flexible racking for large cookware
- With soft-close drawers, and knock to pause convenience

- Wi-Fi capability and a SmartHQ™ app for remote control and notifications

DIMENSIONS

Height	34 - 36 3/8"
Width	23 9/16"
Depth	22 1/2"

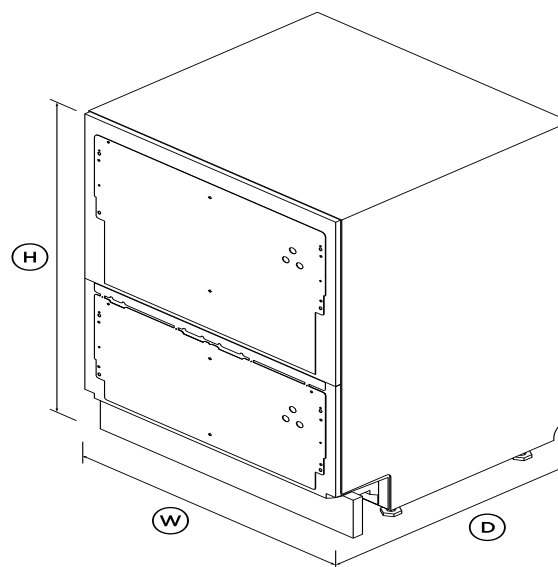

FEATURES & BENEFITS

SEAMLESS INTEGRATION

Install your DishDrawer™ Dishwasher into an existing kitchen space or integrate into kitchen cabinetry. The touch-sensitive control panel is located inside this Integrated model, leaving an uninterrupted exterior that blends seamlessly with surrounding cabinetry.

EASE OF USE

DishDrawer™ Dishwashers are beautiful to use with soft-close drawers. The tall top drawer fits your larger plates and dishes up to 12 1/4 inches, while the bottom drawer is ideal for small washes. Flexible racking includes height-adjustable cup racks and wine glass supports.

TRUE HALF LOAD

Both drawers fit a true half load. Each drawer operates independently, so you can wash one load while stacking the other drawer, or wash simultaneously on separate cycles.

FLEXIBLE WASH OPTIONS

Eight wash programs including Auto, 60min and Glassware, while modifiers such as Sanitize, Dry+ and Quiet provide added wash flexibility. The Quiet wash modifier reduces the noise on some cycles while maintaining performance - perfect for late night washing.

DESIGN QUALITY

Every detail has been carefully crafted using quality materials, from the easy-to-clean stainless steel interior to the spray arm sensor that detects jams for increased wash confidence.

KNOCK TO PAUSE

For ease-of-use, these DishDrawer™ Dishwashers have a knock to pause function. A knock on the front panel will pause the dishwasher, which can be restarted by using the start button.

QUIET PERFORMER

Running at a low decibel rating of 44dBA, these DishDrawer™ Dishwashers do their job without making a fuss. The combination of intelligent technology and simple mechanics means greater reliability and excellent wash performance.

SPECIFICATIONS

Accessories

Contemporary round handle	AHS-OBDD-60S
Contemporary square fine	AHD5-OBDD-60S

Contemporary square handle	AHD3-OBDD-60S
Cutlery basket	•
Kickstrip	•
Knife clip and multipurpose	•
Professional round flush handle	AHP3-DWDD-SX
Professional round handle kit	AHP2-DWDD-SX
Stainless steel door panel	ADDD24DTPX

Capacity and loading

Accommodates round plates	12.25" (top) 11" (bottom)
Adjustable height, foldable	•
Fold down tines	•
Pitch adjustable tines	•
Place settings	14
Wine glass supports with	•

Consumption

Water usage (per wash cycle)	3.7 gal running both tubs
------------------------------	----------------------------------

Controls

Child lock	•
Electronic fault/Diagnostic	•
End of cycle beeps	•
Energy saving delay start	•
Internal wash selector	•
Intuitive capacitive touch	•
Knock to pause	•
Rinse aid indicator light	•
Spray arm sensing	•
Wi-Fi connectivity	•

Features

Built-in water softener	•
Fan assisted drying	•
Flood protection	•
Flow through detergent	•
Internal tub material	Stainless steel
Quiet operation	•
SmartDrive™ technology	•
Soft close drawer	•

Performance

Noise on standard cycle top	44dBA
-----------------------------	--------------

Power requirements

Amperage	10A
Rated current	15A
Supply frequency	60Hz
Supply voltage	120V

Product dimensions

Depth	22 1/2"
Height	34 - 36 3/8"
Width	23 9/16"

Warranty

Parts and labor	Limited 2 years
-----------------	------------------------

Wash Program Modifiers

Dry +	•
-------	---

Quiet	•
Sanitize	•
Wash modifiers	3

Wash Programs

60 min	•
Auto	•
Eco	•
Glassware	•
Heavy	•
Light	•
Medium	•
Rinse	•
Wash programs	8







Water connection

Inlet water temperature	max 140°F
Supplied hose to suit 3/8"	•

SKU	82163
-----	--------------

The product dimensions and specifications in this page apply to the specific product and model. Under our policy of continuous improvement, these dimensions and specifications may change at any time. You should therefore check with Fisher & Paykel's Customer Care Centre to ensure this page correctly describes the model currently available. ? Fisher & Paykel Appliances Ltd 2020

Other product downloads available at fisherpaykel.com

-  [Energy Label Double DishDrawer](#)
-  [Wash Program Data Sheet](#)
-  [Service & Warranty](#)
-  [Wash Program Data Sheet](#)
-  [User Guide DishDrawer™](#)
-  [Data Sheet](#)
-  [Specification Guide](#)



A PEACE OF MIND SALE

24 Hours 7 Days a Week Customer Support

T 1.888.936.7872 **W**www.fisherpaykel.com